

onn

QUICK START GUIDE

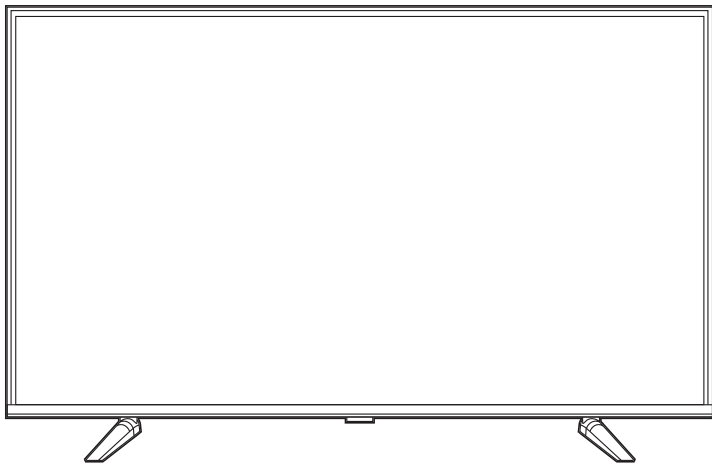

Product features and specifications may vary by model. Illustrations and descriptions in this guide are for reference only and may not exactly match your specific TV.

POWERED BY
VIZIO

Overview

What's included:

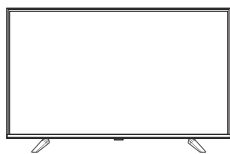

onn POWERED BY VIZIO



TV Remote

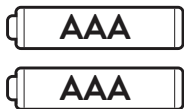

2 x AAA Batteries
for Remote

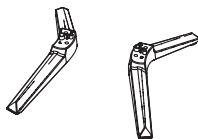

TV Stand



Screws

Tools required:

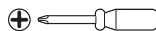

Phillips
Head
Screwdriver



Wireless
Router
(needed for
streaming)



Computer,
Tablet, or
Smartphone
(needed for setup)



Internet
Connection
(needed for
streaming)

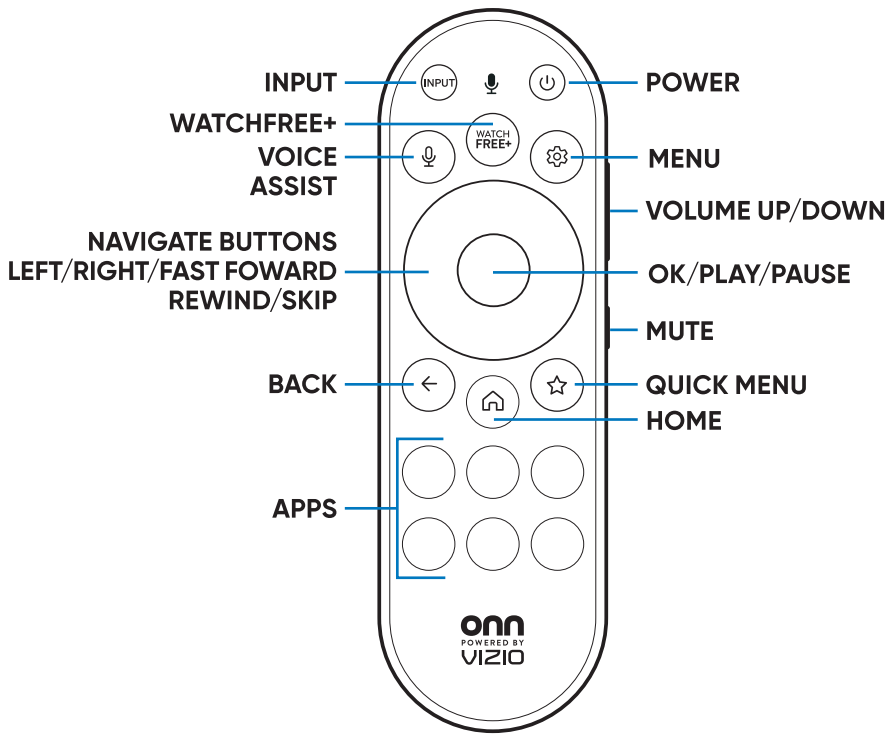

Power your TV remote by inserting the included batteries carefully matching (+) and (-) indicated inside the battery compartment.

For product assistance &
missing or replacement parts:

WE CAN HELP

1-855-472-7400

ONLINE CHAT:

onntvsupport.com

Your product comes with a 2-Year Warranty
from the date of purchase.

For warranty information, please see the
product warranty located in the TV box.

Find more at **Walmart.com**

We recommend keeping your TV box for the duration of
your warranty. See your product warranty for details.

Assembly

1. INSTALLING THE STANDS

Using a **Phillips screwdriver**

Do not install the stands if you want to wall mount your TV. See your wall mount instructions for mount installation details.

Place the TV screen-down on a clean, flat, soft surface (e.g.: blanket) to prevent scratches or damage to the screen.

Use a Phillips screwdriver to attach each stand with the provided screws. Make sure the stand screws are fully tightened and the stands do not shift or move.

Place the TV upright on a stable, level surface.

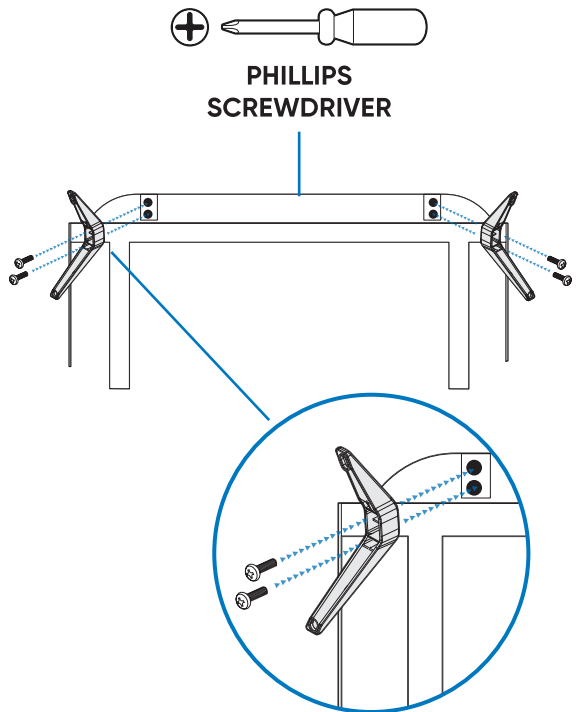

2. CONNECTING DEVICES

HDMI

connect a Blu-ray, DVD player, gaming console or other devices

Best Quality

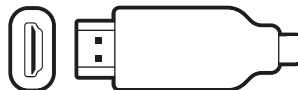

DIGITAL OPTICAL

connect an external digital audio system

Better Quality

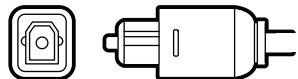

COAXIAL

connect to antenna/cable

Good Quality



2. CONNECTING DEVICES (continued)

USB

connect for photos, music,
movies and more



CONNECTING TO POWER

After connecting all your devices, connect the power cord to a power outlet. The TV enters standby mode and its indicator light turns red.

Setup

ACTIVATION:

Have your mobile device ready for the VIZIO app download.

If you have a wireless network, have the network password ready.

The first time you turn on the TV, the on-screen instructions will guide you through each of the steps necessary to get your TV ready to watch.

NOTE:

VIZIO doesn't charge for activation support - **beware of scams.**