

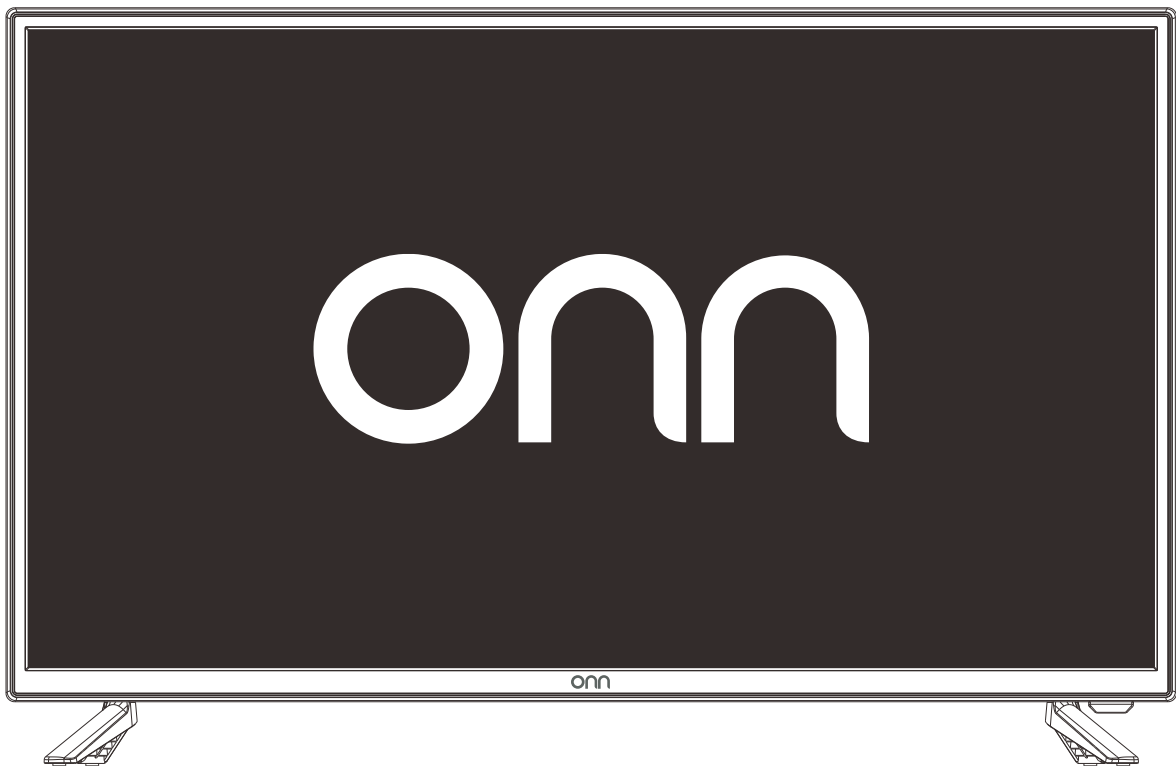

# USER MANUAL

## DIGITAL LED TV

Product may vary. Please refer to the actual product.



Please read all the instructions carefully before using this TV, and keep the manual for future reference.



# CONTENTS

<b>IMPORTANT SAFETY INSTRUCTIONS</b> .....	3
<b>ADDITIONAL SAFETY INFORMATION</b> .....	4
<b>GETTING TO KNOW YOUR TV</b> .....	5
WHAT IS INCLUDED?.....	5
FRONT VIEW.....	6
BACK VIEW.....	6
REMOTE CONTROL .....	7
<b>WALL MOUNTING</b> .....	9
<b>INSTALLING THE STAND</b> .....	9
<b>INSTALLING REMOTE BATTERIES</b> .....	9
<b>CONNECTING DEVICES</b> .....	10
CABLE/SATELLITE BOX.....	10
ANTENNA.....	12
DVD/BLU-RAY PLAYER.....	12
GAME CONSOLE.....	14
LAPTOP/COMPUTER .....	15
FLASH DRIVE .....	15
HEADPHONES.....	16
SPEAKERS .....	16
STREAMING DEVICES.....	17
<b>FIRST USE</b> .....	18
PLUGGING IN THE TV.....	18
SETUP WIZARD .....	18
<b>OPERATING THE TV</b> .....	19
TURNING ON/OFF .....	19
SELECTING AN INPUT SOURCE .....	19
SELECTING CHANNELS.....	19
ADJUSTING THE VOLUME.....	19
VIEWING USB MULTIMEDIA.....	19
<b>CUSTOMIZING TV SETTINGS</b> .....	20
NAVIGATING THE SETTINGS MENU .....	20
PICTURE .....	21
AUDIO.....	21
TIME.....	22
SETUP .....	22
LOCK .....	24
CHANNEL.....	25
<b>SEARCHING FOR CHANNELS</b> .....	26
<b>SETTING PARENTAL CONTROLS</b> .....	26
CHOOSING VIEWER RATINGS.....	26
CHANGING THE PASSWORD.....	27
BLOCKING CONTENT.....	27
<b>MAINTAINING YOUR TV</b> .....	28
<b>SPECIFICATIONS</b> .....	28
<b>TROUBLESHOOTING</b> .....	29
<b>LEGAL NOTICES</b> .....	31

# IMPORTANT SAFETY INSTRUCTIONS

- **Read these instructions** – All the safety and operating instructions should be read before this product is operated.
- **Keep these instructions** – The safety and operating instructions should be retained for future reference.
- **Heed all warnings** – All warnings on the appliance and in the operating instructions should be adhered to.
- **Follow all instructions** – All operating and use instructions should be followed.
- **Do not use this apparatus near water** – The appliance should not be used near water or moisture – for example, in a wet basement or near a swimming pool, and the like.
- Clean only with a dry cloth.
- **Do not** block any ventilation openings. Install in accordance with the manufacturer's instructions.
- **Do not** install near any heat sources such as radiators, heat registers, stoves, or other apparatus (including amplifiers) that produce heat.
- **Do not** defeat the safety purpose of the polarized or grounding-type plug. A polarized plug has two blades with one wider than the other. A grounding-type plug has two blades and a third grounding prong. The wide blade or the third prong are provided for your safety. If the provided plug does not fit into your outlet, consult an electrician for replacement of the obsolete outlet.
- Protect the power cord from being walked on or pinched particularly at plugs, convenience receptacles, and the point where they exit from the apparatus.
- Only use attachments/accessories specified by the manufacturer.
- Use only with the cart, stand, tripod, bracket, or table specified by the manufacturer, or sold with the apparatus. When a cart is used, use caution when moving the cart/apparatus combination to avoid injury from tip-over.



- Unplug this apparatus during lightning storms or when unused for long periods of time.
- Refer all servicing to qualified service personnel. Servicing is required when the apparatus has been damaged in any way, such as the power-supply cord or plug is damaged, liquid has been spilled or objects have fallen into the apparatus, the apparatus has been exposed to rain or moisture, does not operate normally, or has been dropped.
- Keep the unit in a well-ventilated environment.

**WARNING:** To reduce the risk of fire or electric shock, do not expose this apparatus to rain or moisture. The apparatus should not be exposed to dripping or splashing. Objects filled with liquids, such as vases should not be placed on the apparatus.

**WARNING:** The batteries shall not be exposed to excessive heat such as sunshine, fire, or the like.

**WARNING:** The main plug is used as a disconnect device. The disconnect device shall remain readily operable.

**WARNING:** To reduce the risk of electric shock, do not remove the cover (or back) as there are no user-serviceable parts inside. Refer servicing to qualified personnel.



 This lightning flash with arrowhead symbol within an equilateral triangle is intended to alert the user to the presence of non-insulated “dangerous voltage” within the product’s enclosure that may be of sufficient magnitude to constitute a risk of electric shock.

 The exclamation point within an equilateral triangle is intended to alert the user to the presence of important operating and maintenance instructions in the literature accompanying the appliance.

 This equipment is a Class II or double insulated electrical appliance. It has been designed in such a way that it does not require a safety connection to electrical earth.

## ADDITIONAL SAFETY INFORMATION

To ensure reliable and safe operation of your new TV, read this user manual carefully, including safety information below.

## Electrical Safety

- The TV set should only be connected to a main power supply with a voltage that matches the label at the rear of the product.
  - To prevent overload, do not share the same power supply socket with too many other electronic components.
  - Do not place any connecting wires where they may be stepped on or tripped over.
  - Do not place heavy items on them, which may damage the leads.
  - Hold the main plug, not the wires, when removing from a socket.
  - During a thunderstorm, or when not using the television for extended period of time, turn off the power switch on the back of the television.
  - Do not allow water or moisture to enter the TV or power adapter. Do NOT use in wet, moist areas, such as bathrooms, steamy kitchens, or near swimming pools.
  - Pull the plug out immediately, and seek professional help if the main plug or cable is damaged, liquid is spilt onto the set, if accidentally exposed to water or moisture, if anything accidentally penetrates the ventilation slots, or if the set does not work normally.
  - Do not remove the safety covers. There are no user serviceable parts inside. Trying to service the unit yourself is dangerous and may invalidate the product's warranty.
  - To avoid battery leakage, remove exhausted batteries from the remote control, or when not using for long period.
  - Do not break open or throw exhausted batteries on a fire.
  - Do not mix old and new batteries.
  - Do not mix Alkaline, Standard (Carbon-Zinc) or Rechargeable (Nickel Cadmium) or (Nickel Metal Hydride) batteries.
  - Unplug the apparatus during lightning storms or when unused for long periods.
  - Refer all servicing to a qualified service personnel. Servicing is required when the apparatus has been damaged in any way, such as power-supply cord or plug is damaged, liquid has been spilled, or objects have fallen into the apparatus, has been exposed to rain or moisture, does not operate normally, or has been dropped.
  - Always connect your television to a power outlet with protective ground connection.
- WARNING:** Never place a television in an unstable location. A television may fall, causing serious personal injury or death. Many injuries, particularly to children, can be avoided by taking simple precautions such as:
- Using cabinets or stands recommended by the manufacturer of the television.
  - Only using furniture that can safely support the television.
  - Making sure that the television is not overhanging the edge of the supporting furniture.
  - Not placing the television on tall furniture (for example, cupboards or bookcases) without anchoring both the furniture and the television to a suitable support.
  - Not placing the television on cloth or other materials that may be located between the television and supporting furniture.
  - Educating children about the dangers of climbing on furniture to reach the television or its controls.
- If your existing television is being retained and relocated, the same considerations as above should be applied.

## Physical Safety

- Do not block ventilation slots in the back cover. You may place the TV in a cabinet, but ensure at least 2" (5 cm) clearance all around.
- Do not tap or shake the TV screen, or you may damage the internal circuits. Take good care of the remote control.
- To clean the TV use a soft dry cloth. Do not use solvents or petroleum-based fluids.
- Do not install near any heat sources such as radiators, heat registers, stoves or other apparatus (including amplifiers) that produce heat.
- Do not defeat the safety purpose of the polarized or grounding-type plug. A polarized plug has two blades with one wider than the other. A grounding type plug has two blades and a third grounding prong, the wide blade, or the third prong is provided for your safety. If the provided plug does not fit into your outlet, consult an electrician for replacement of the obsolete outlet.
- Protect the power cord from being walked on or pinched particularly at plugs.

# GETTING TO KNOW YOUR TV

## WHAT IS INCLUDED?

Product may vary. Please refer to the actual product.

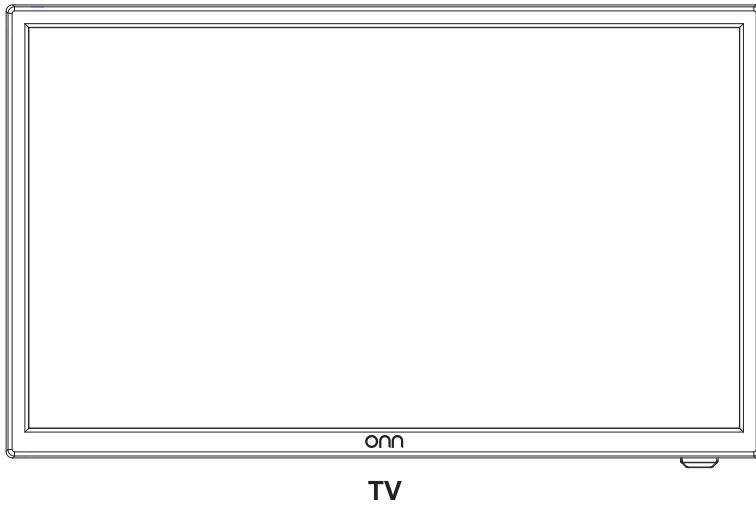

**Power Cord**  
(some models have separate power cords)

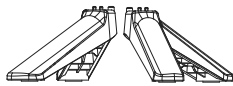

**TV Stands**



**Screws for TV Stands (4)**

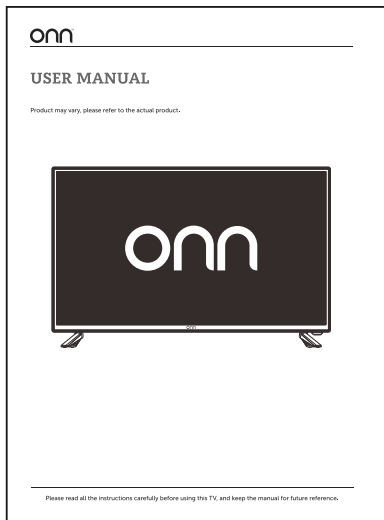

**User Manual**

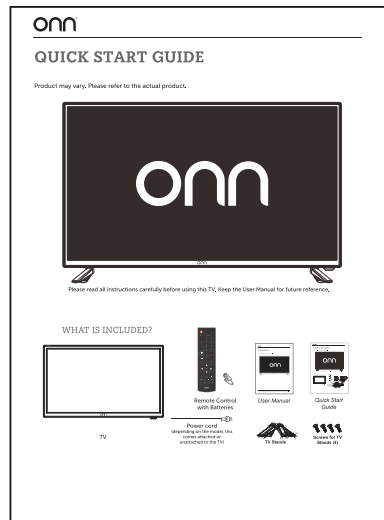

**Quick Start Guide**



**Remote Control with Batteries**

# GETTING TO KNOW YOUR TV (CONT.)

## FRONT VIEW

Product may vary. Please refer to the actual product.

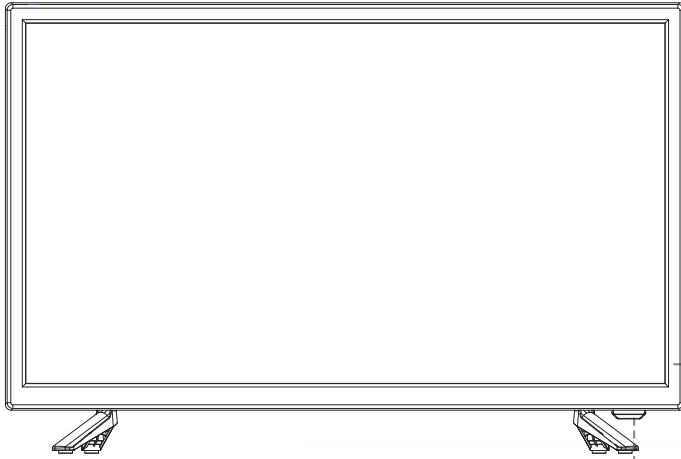

<b>VOL+ / VOL-</b>	Adjust the volume.
<b>CH+ / CH-</b>	Select a channel.
<b>INPUT</b>	Select a different input source.
<b>MENU</b>	Display the on-screen menu.
<b>POWER</b>	Switch the TV between On and Standby mode.

FEATURE	DESCRIPTION
<b>LED</b>	Indicates when the TV is turned on or in standby mode.
<b>IR SENSOR</b>	Receives signals from your remote.

## BACK VIEW

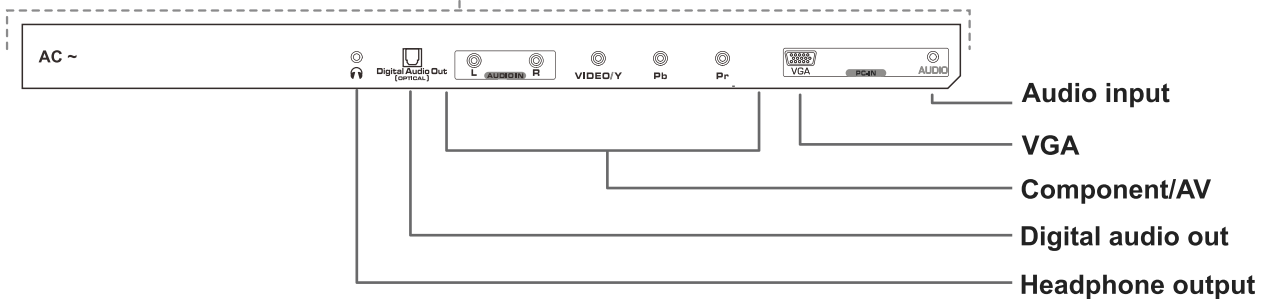
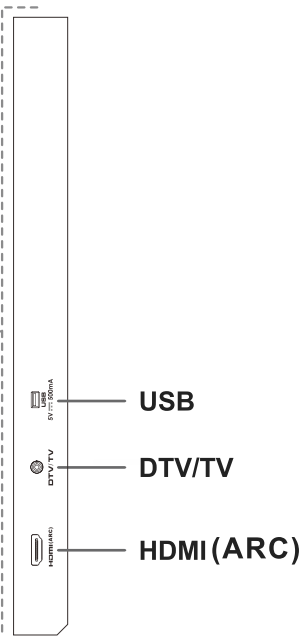
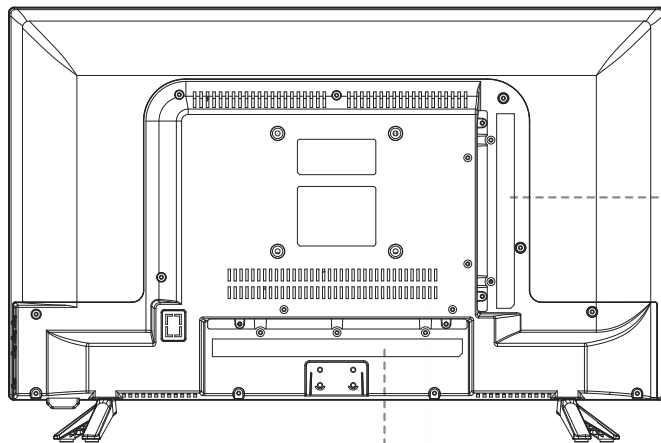

# GETTING TO KNOW YOUR TV (CONT.)

## REMOTE CONTROL

- If there is light around the TV, the remote control may fail or work abnormally.
- Remove the batteries from the remote control when not in use for a long period of time.
- To prevent battery leakage, which may result in bodily injury or damage to the remote:
  1. Install all batteries correctly, and as marked on the remote control.
  2. Do not mix old and new batteries and do not mix alkaline, standard (carbon-zinc) or rechargeable (NiCad, NiMg, etc.) batteries.

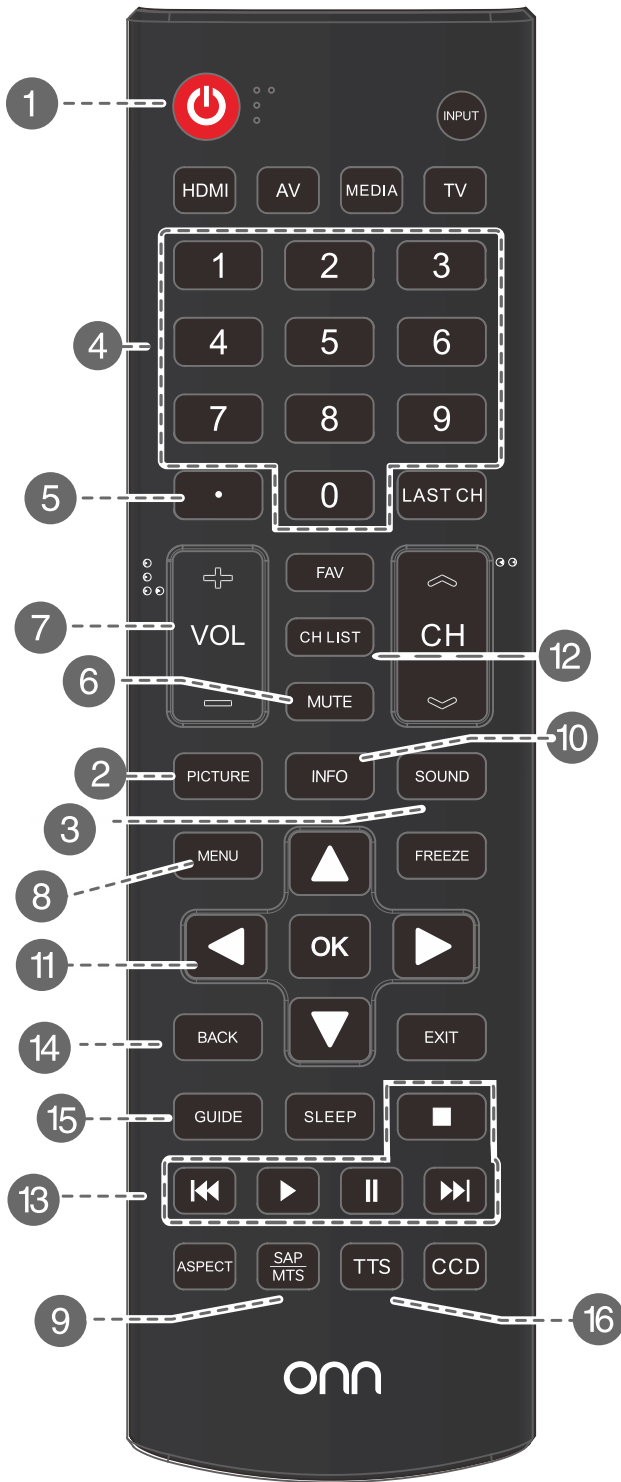

#	FEATURE	DESCRIPTION
1	Power	Switch the TV between on and standby mode.
2	Picture Mode	Change the picture mode to , Dynamic,Standard,Movie,User.
3	Sound Mode	Change the sound mode to , Standard,User,Movie,Sports,Music.
4	Number pad (0-9)	Select a program.
5	Sub-channel	Enter a program sub-channel, such as 2-1.
6	Mute	Mute and restore your TV sound.
7	Volume Adjust	Adjust the volume.
8	TV Setup Menu	Display the on-screen menu.
9	MTS	Switch between audio channels: Stereo, Mono, or SAP.
10	Information	Display the present screen information such as the current channel and input source.
11	Directional arrows	Navigate the menus and adjust the system settings.
12	CHANNEL LIST	Display the channel list.
13	Playback	Control media playback.
14	BACK	Return to previous menu.
15	GUIDE	Electronic Program Guide
16	TTS	TTS(Text-TO-Speech):Press this button to adjust TTS on or off.

# GETTING TO KNOW YOUR TV (CONT.)

## REMOTE CONTROL (CONT.)

#	FEATURE	DESCRIPTION
17	MEDIA	Switch to the MEDIA input.
18	ASPECT	Change the aspect ratio: Normal, Wide, Cinema, FULL/Point TO Point (HDMI/VGA).
19	Sleep	Set the TV sleep timer: off, 5, 10, 15, 30, 60, 90, 120, 180, or 240 minutes.
20	LAST CH	Return to previous channel.
21	Channel Selection	Select a channel.
22	INPUT	Select an input source: TV, AV, Component, HDMI(ARC), PC, Media
23	FREEZE	Freeze the picture.
24	ENTER/OK	Confirm the selection in the menu.
25	EXIT	Exit the on-screen menu.
26	CCD	Change closed caption settings: CC On, CC Off, CC on Mute.
27	FAV	Display the favorite channel list.

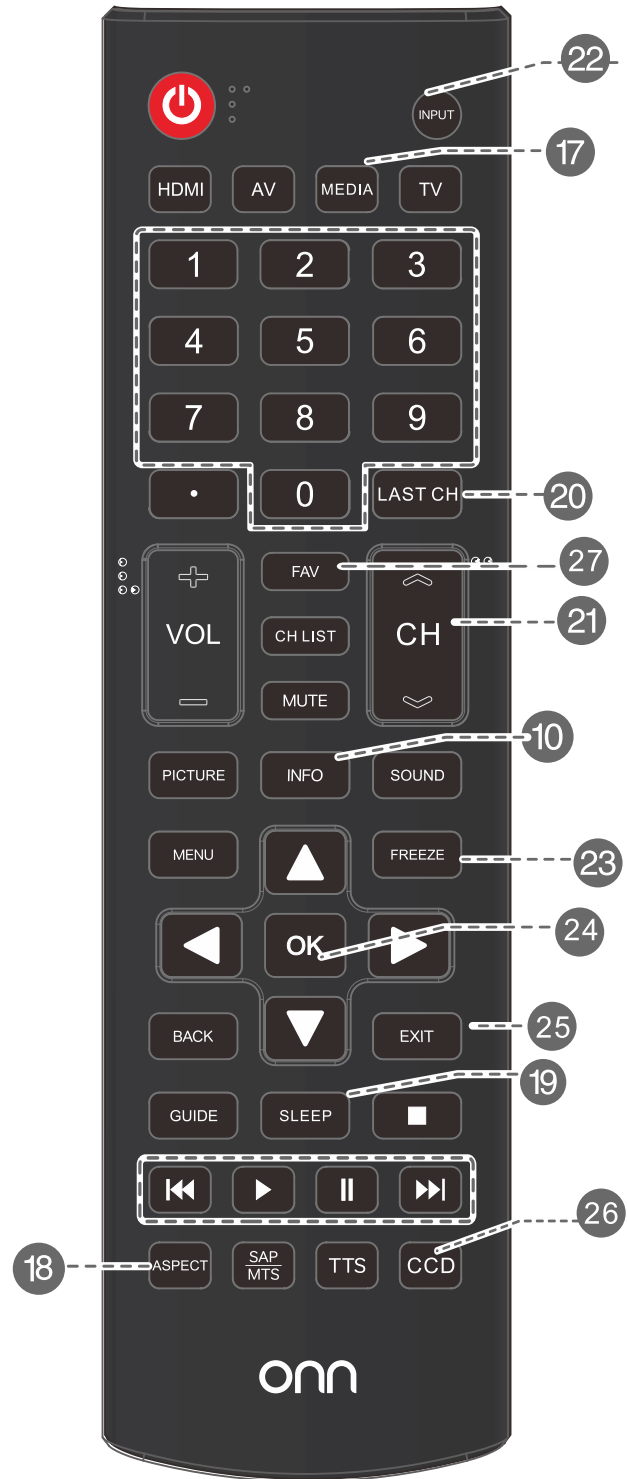

## WALL MOUNTING

Reference the instructions that came with your wall mounting hardware.

**i** Your new TV is heavy. Consult with a professional installer to wall mount your new TV.

## INSTALLING THE STAND

**i** Do not install the stands if you want to mount your TV to the wall. See the instructions that came with your wall mounting hardware.

**You will need:** Phillips screwdriver (not included) 

1. Remove any plastic wrapping from the TV and stands, and place the TV screen-down on a clean, flat surface to prevent scratches or damage to the screen.
2. Attach each stand into place with the four provided screws and a Phillips screwdriver.

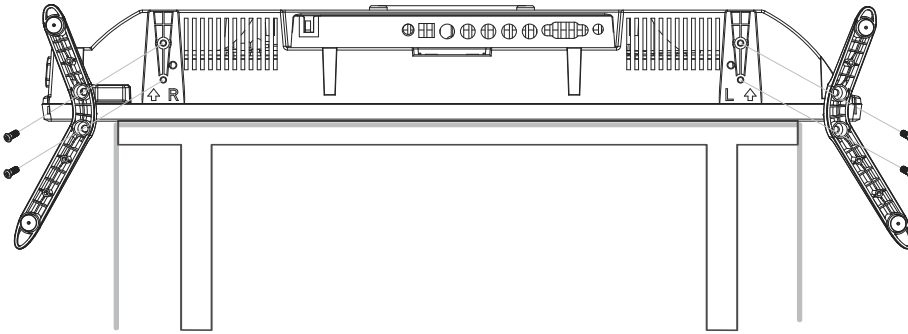

3. Place the TV on a stable, level surface.

## INSTALLING REMOTE BATTERIES

1. Remove the cover from the remote control's battery compartment.

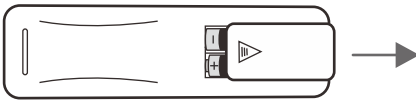

2. Insert two AAA batteries, making sure to match the + and – terminals to the symbols in the compartment.

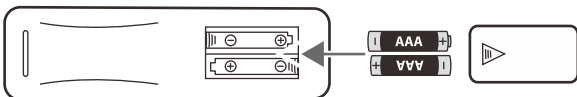

3. Replace the battery cover.



**i** Remove the batteries from the remote control when not in use for a long period time.

Onn recommends responsible battery handling when your batteries have reached the end of their useful life. Please properly dispose of your batteries in a manner consistent with your community's laws and waste management requirements. You can visit <http://www.call2recycle.org/> to find your local regulations, as well as drop-off locations.

## CONNECTING DEVICES

### CABLE/SATELLITE BOX

You can use HDMI, composite (AV), component, or coaxial to connect your cable/satellite box to your TV.

#### HDMI

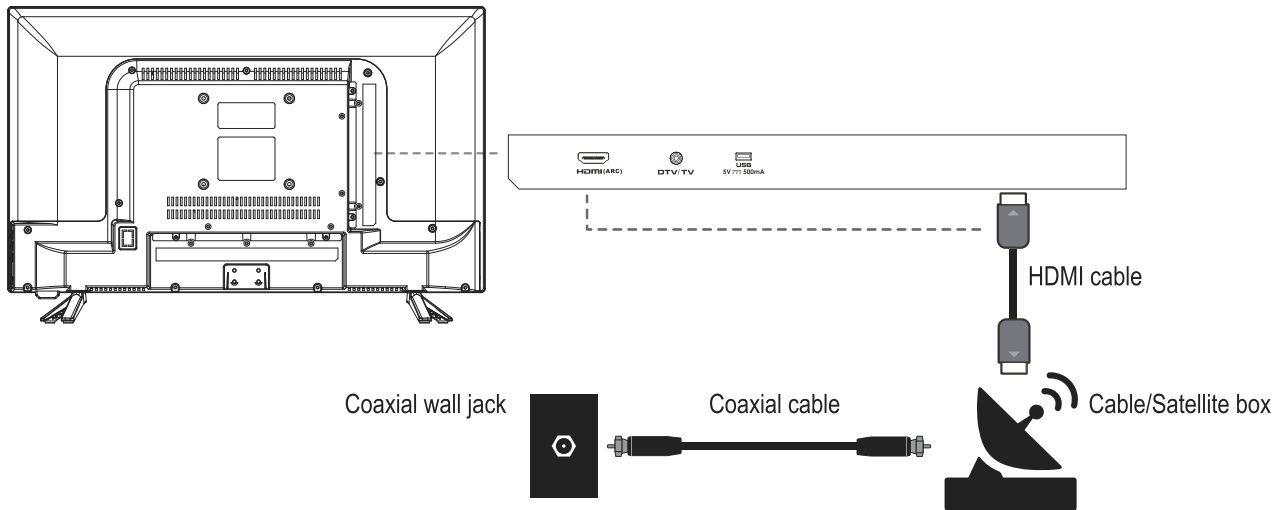

1. Connect an HDMI cable (not included) to the HDMI OUT port on your cable/satellite box.
2. Connect the other end of the cable to the **HDMI** port on the back of your TV.
3. Connect a coaxial cable (not included) from your cable/satellite box to a coaxial wall jack.
4. Follow instructions from your cable service provider to search for channels



To use the cable/satellite box, press the **INPUT** button repeatedly to select the port you connected it to (**HDMI**).

#### COMPONENT

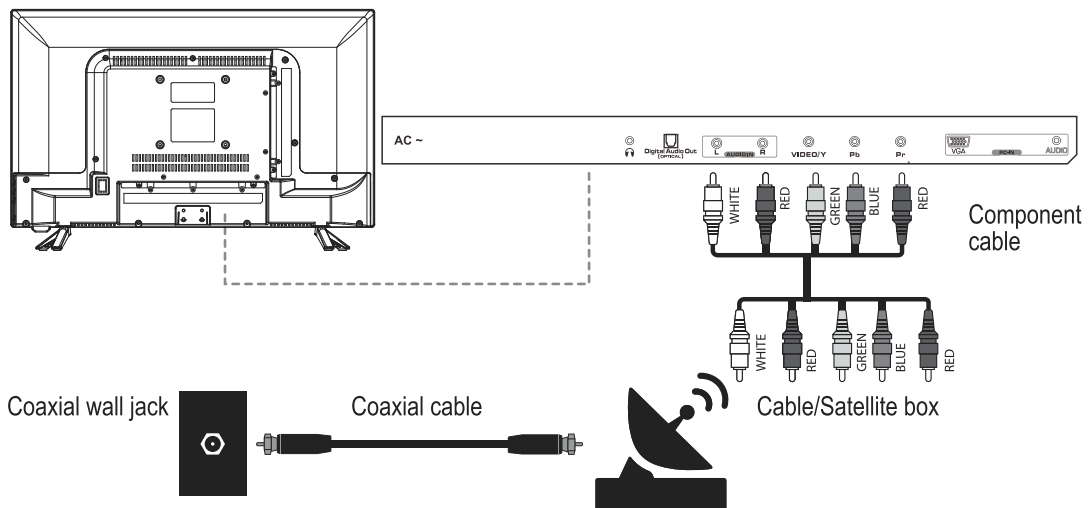

1. Connect a component cable's (not included) red, blue, and green connectors to your cable/satellite box.
2. Connect the other end of the component cable to the **VIDEO/Y, Pb, and Pr** jacks on the back of your TV, matching the cable's colored connectors to the jacks.
3. Connect an audio cable's (not included) white and red connectors to the audio out jacks on your cable/satellite box.
4. Connect the other end of the audio cable to the **AUDIO IN** jacks on the back of your TV.
5. Connect a coaxial cable (not included) from your cable/satellite box to a coaxial wall jack.
6. Follow instructions from your cable service provider to search for channels



- Some component cables have the white and red audio connectors built in. If they are not, you will need a separate RCA audio cable.
- Make sure that you match the connectors' colors with the jacks you are connecting them to.
- To use the cable/satellite box, press the **INPUT** button repeatedly to select **Component/AV**.

# CONNECTING DEVICES (CONT.)

## CABLE/SATELLITE BOX (CONT.)

### COMPOSITE (AV)

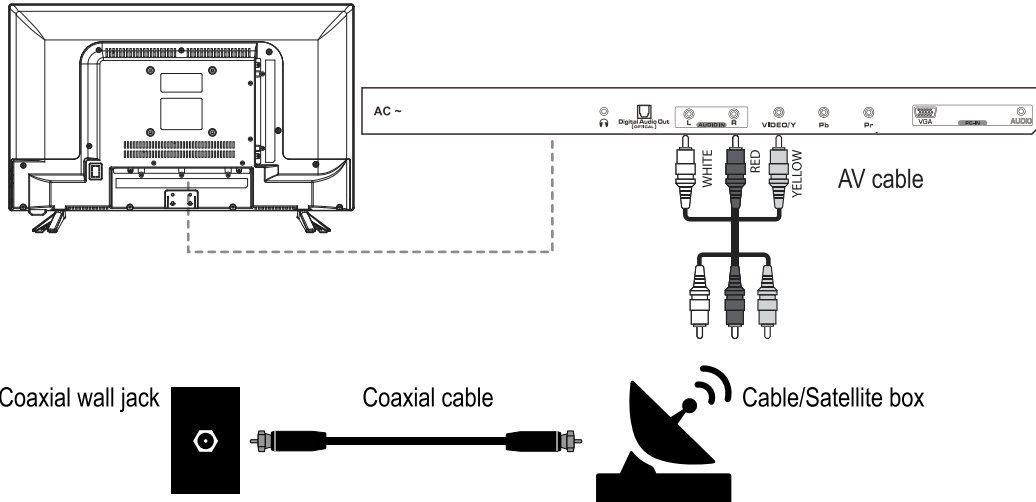

1. Connect an AV (composite) cable (not included) to the AV jacks on your cable/satellite box.
2. Connect the other end of the cable to the **AUDIO IN** and VIDEO/Y jacks on the back of your TV. The cable connectors' colors should match the TV jacks' colors.
3. Connect a coaxial cable (not included) from your cable/satellite box to a coaxial wall jack.
4. Follow instructions from your cable service provider to search for channels

**i** • Make sure that you match the connectors' colors with the jacks you are connecting them to.  
 • To use the cable/satellite box, press the **INPUT** button on your remote control repeatedly to select **Component/AV**.

### COAXIAL

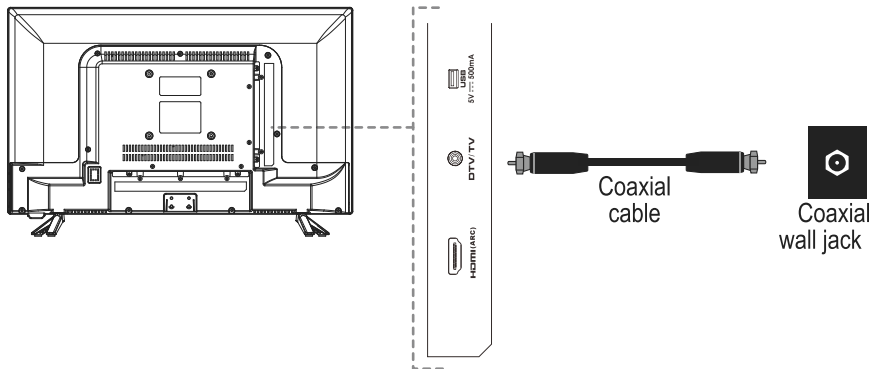

1. Connect a coaxial cable (not included) to your cable/satellite box.
2. Connect the other end of the cable to the **DTV/TV** jack on your TV.
3. Connect the other end of the coaxial cable to a coaxial wall jack.
4. See "Searching For Channels" on page 27 to run a channel scan

**i** • To use the cable/satellite box, press the **INPUT** button repeatedly to select **TV**.  
 • If you are switching between an antenna and cable/satellite box, go to your TV's Channel settings and switch to Air (antenna) or Cable (cable/satellite box).

## CONNECTING DEVICES (CONT.)

### ANTENNA

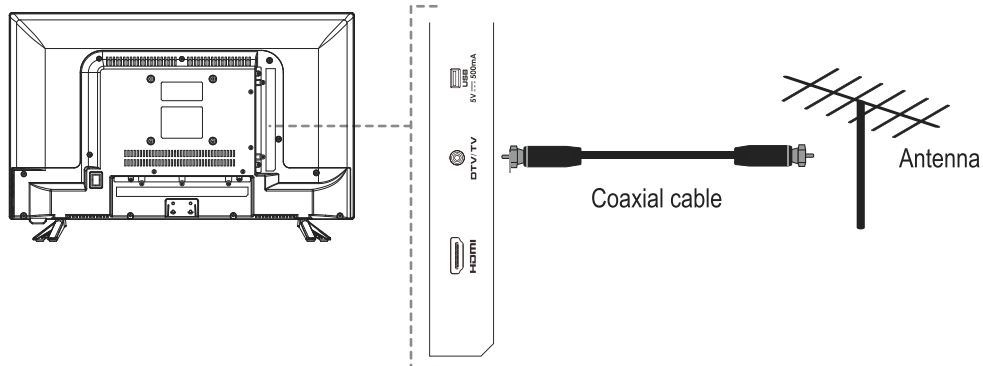

1. Connect a coaxial cable (not included) to your antenna.
2. Connect the other end of the cable to the **DTV/TV** jack on your TV.
3. See **“SEARCHING FOR CHANNELS” on page 27** to run a channel scan.

- To use the antenna, press the **INPUT** button repeatedly to select **TV**.
- If you are switching between an antenna and cable/satellite box, go to your TV's Channel settings and switch to Air (antenna) or Cable (cable/satellite box).

### DVD/BLU-RAY PLAYER

You can use HDMI, composite (AV), component, or coaxial to connect your DVD/Blu-ray player to your TV.

#### HDMI

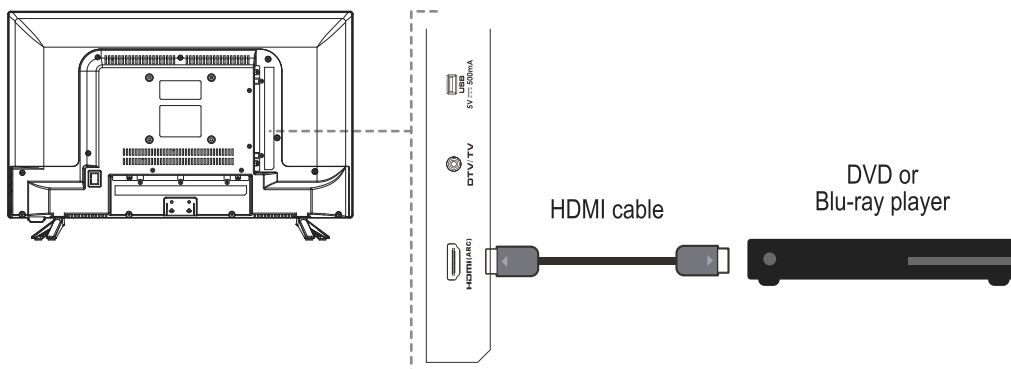

1. Connect an HDMI cable (not included) to the HDMI OUT port on your DVD or Blu-ray player.
2. Connect the other end of the cable to the **HDMI** port on the back of your TV.

- To use the DVD/Blu-ray player, press the **INPUT** button repeatedly to select the port you connected it to (**HDMI**)

# CONNECTING DEVICES (CONT.)

## DVD/BLU-RAY PLAYER (CONT.)

### COMPONENT

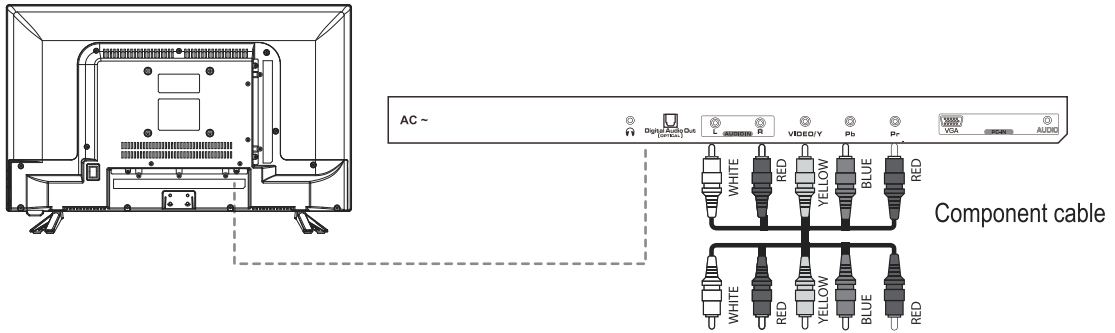

1. Connect a component cable's (not included) red, blue, and green connectors to your DVD or Blu-ray player.
2. Connect the other end of the component cable to the **VIDEO/Y, Pb, and Pr** jacks on the back of your TV, matching the cable's colored connectors to the jacks.
3. Connect an audio cable's (not included) white and red connectors to the audio out jacks on your DVD or Blu-ray player.
4. Connect the other end of the audio cable to the **AUDIO IN** jacks on the back of your TV.

**i**

- Some component cables have the white and red audio connectors built in. If they are not, you will need a separate RCA audio cable.
- Make sure that you match the connectors' colors with the jacks you are connecting them to.
- To use the DVD/Blu-ray player, press the **INPUT** button repeatedly to select **Component/AV**.

### COMPOSITE (AV)

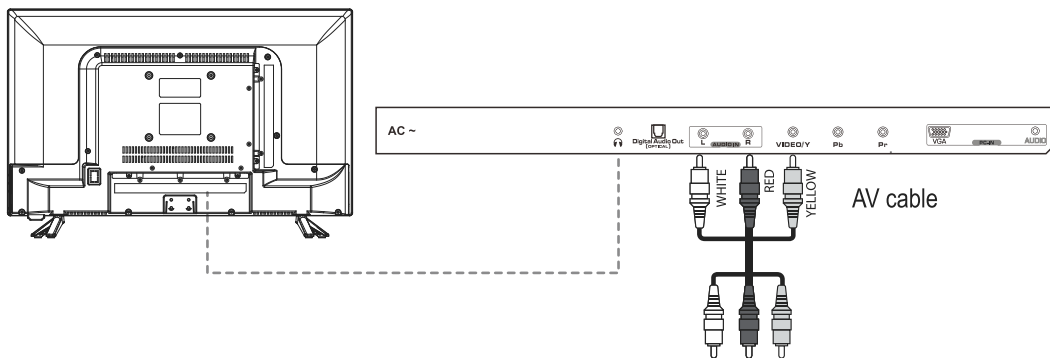

1. Connect an AV (composite) cable (not included) to the AV jacks on your DVD or Blu-ray player.
2. Connect the other end of the cable to the **AUDIO IN** and **VIDEO/Y** jacks on the back of your TV. The cable connectors' colors should match the TV jacks' colors.

**i** To use the DVD/Blu-ray player, press the **INPUT** button repeatedly to select **Component/AV**.

## CONNECTING DEVICES (CONT.)

### GAME CONSOLE

You can use HDMI or composite (AV) to connect your game console to your TV.

#### HDMI

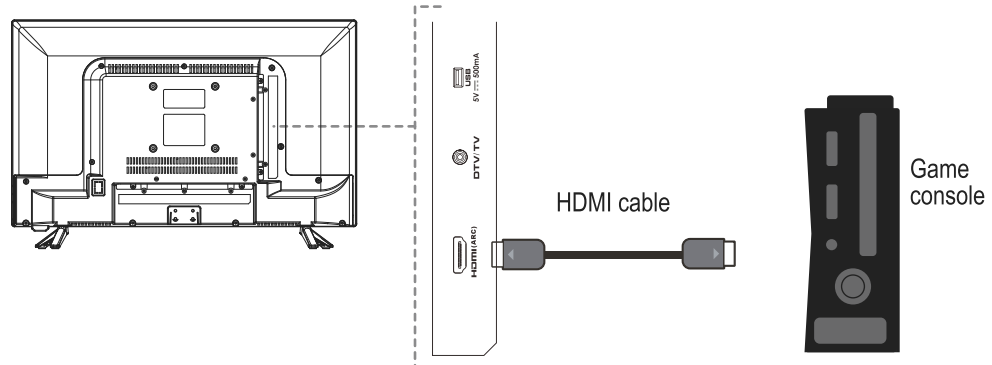

1. Connect an HDMI cable (not included) to the HDMI OUT port on your game console.
2. Connect the other end of the cable to the **HDMI** port on the back of your TV.

**i** To use the game console, press the **INPUT** button repeatedly to select the port you connected it to (**HDMI 1**, **HDMI 2**, or **HDMI 3**).

#### COMPOSITE/AV

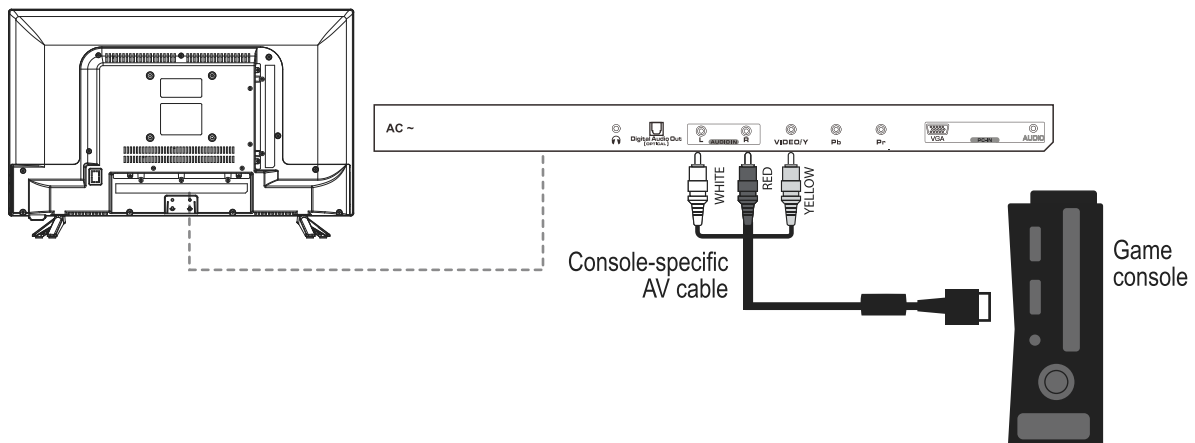

1. Connect an AV (composite) cable (not included) to the AV jacks on your game console.

**i** You may need a console-specific cable for AV connections. See your game console's instructions for more information.

2. Connect the other end of the cable to the **AUDIO IN** and **VIDEO/Y** jacks on the back of your TV. The cable connectors' colors should match the TV jacks' colors.

**i** To use the game console, press the **INPUT** button repeatedly to select **Component/AV**.

# CONNECTING DEVICES (CONT.)

## LAPTOP/COMPUTER

You can use HDMI or VGA to connect your laptop/computer to your TV.

### HDMI

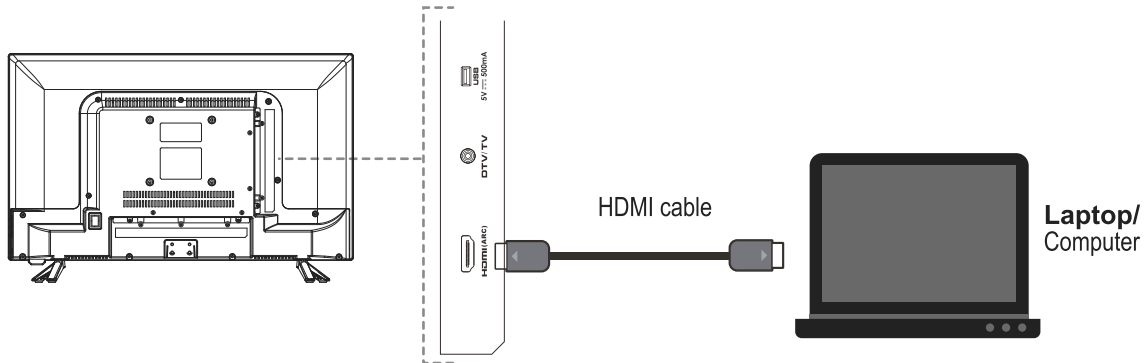

1. Connect an HDMI cable (not included) to the HDMI OUT port on your laptop/computer.
2. Connect the other end of the cable to the **HDMI** port on the back of your TV.

**i**

- To use the computer, press the **INPUT** button repeatedly to select the port you connected it to (**HDMI 1**, **HDMI 2**, or **HDMI 3**).
- You may need to adjust the display properties on your laptop/computer.

### VGA

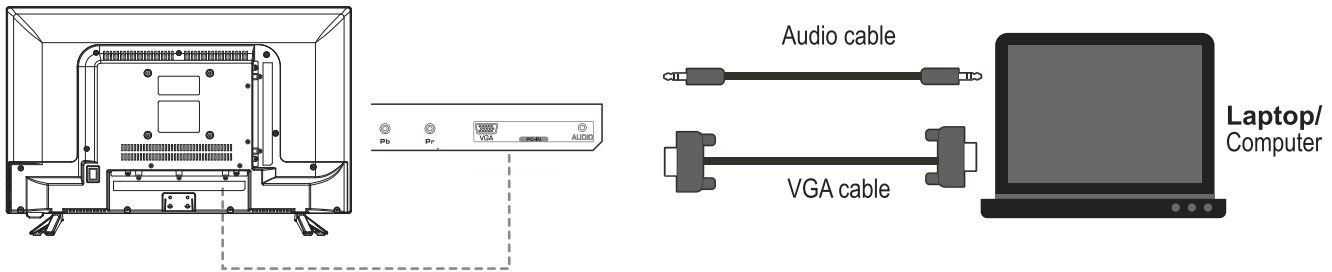

1. Connect a VGA cable (not included) to the VGA port on your laptop/computer.
2. Connect the other end of the cable to the **VGA** port on the back of your TV.
3. If you want to play audio, connect a 3.5 mm audio cable from your computer's audio jack to the **PC IN AUDIO** jack on your TV.

**i**

- To use the computer, press the **SOURCE** button repeatedly to select **VGA**.
- You may need to adjust the display properties on your laptop/computer.

## FLASH DRIVE

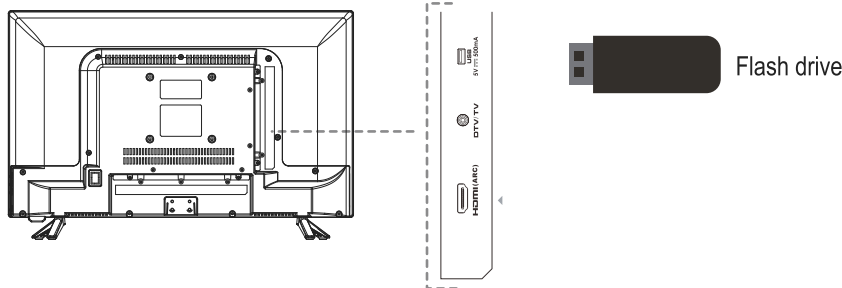

- Connect your USB Type-A flash drive to your TV's USB port.

**i** To use the flash drive, press the **USB** button on your remote, or press the **INPUT** button repeatedly to select the **MEDIA** input source. See **“VIEWING USB MULTIMEDIA”** on **page 20** for more information.

## CONNECTING DEVICES (CONT.)

### HEADPHONES

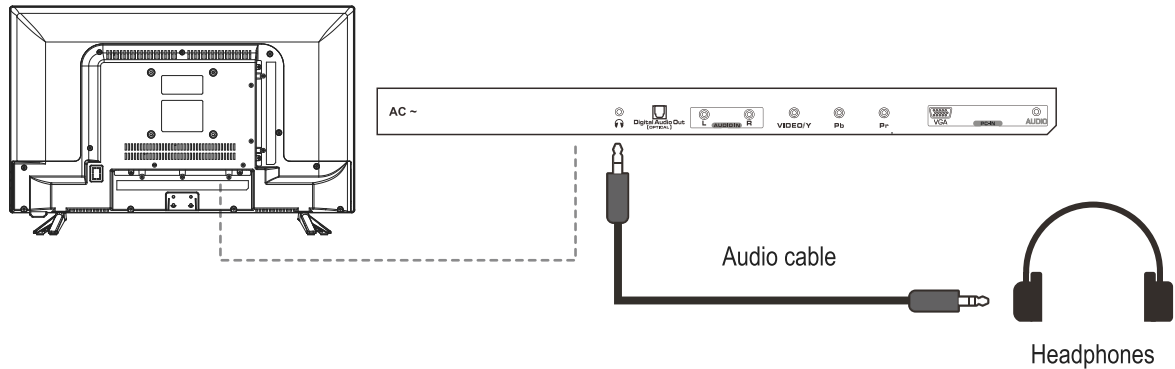

- Connect a 3.5 mm audio cable to the  headphone jack on the back of your TV.

### SPEAKERS

You can use a digital optical cable, 3.5 mm audio cable, or 3.5 mm-to-RCA cable to connect your speakers to your TV.

#### DIGITAL OPTICAL CABLE

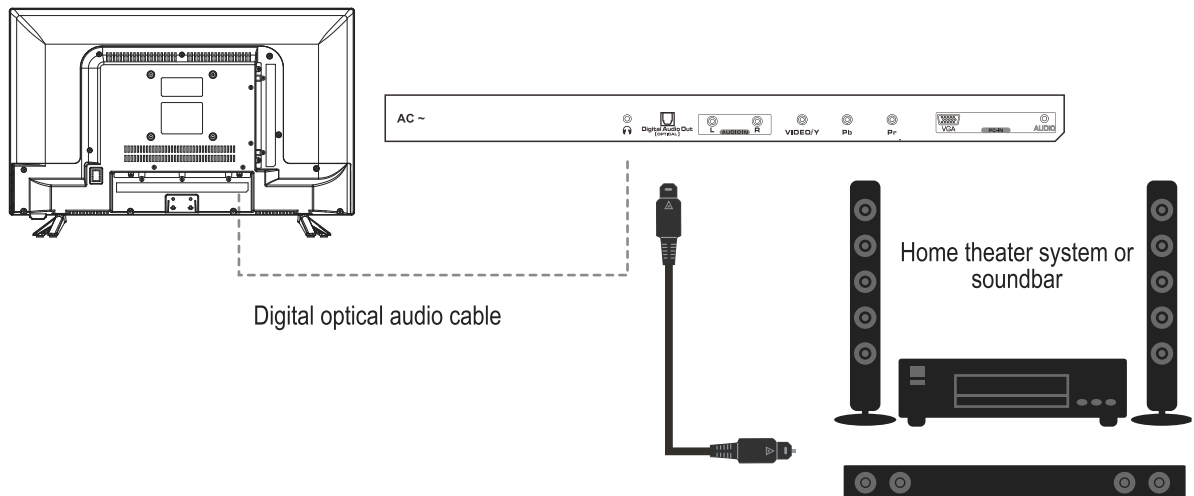

1. Connect a digital optical audio cable (not included) to your audio device.
2. Connect the other end of the cable to the **Digital Audio Out (OPTICAL)** jack on the back of your TV.
3. When your TV is connected to power, open the Audio menu and make sure that the Digital Audio Output option is set to **PCM**:
  - Press the **MENU** button to display the main menu.
  - Press the **▼ ▲** buttons to select the Audio menu, then press the **▶** button or **OK** to make changes in the category.
  - Press the **▼ ▲** buttons to select the **Digital Audio Output** setting, then press the **◀ ▶** buttons to change it to **PCM**.
  - Press the **EXIT** button to save your changes and close the menu.

# CONNECTING DEVICES (CONT.)

## SPEAKERS (CONT.)

### 3.5 MM AUDIO CABLE

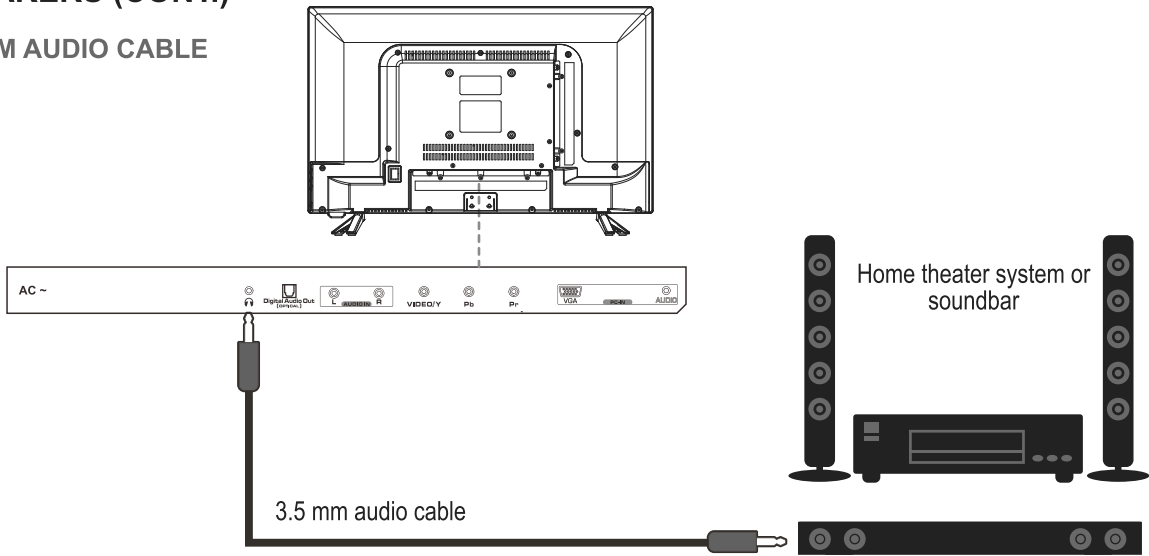

- Connect a 3.5 mm audio cable from the headphone jack on the back of your TV to your home theater system or soundbar.

### 3.5 MM TO RCA CABLE

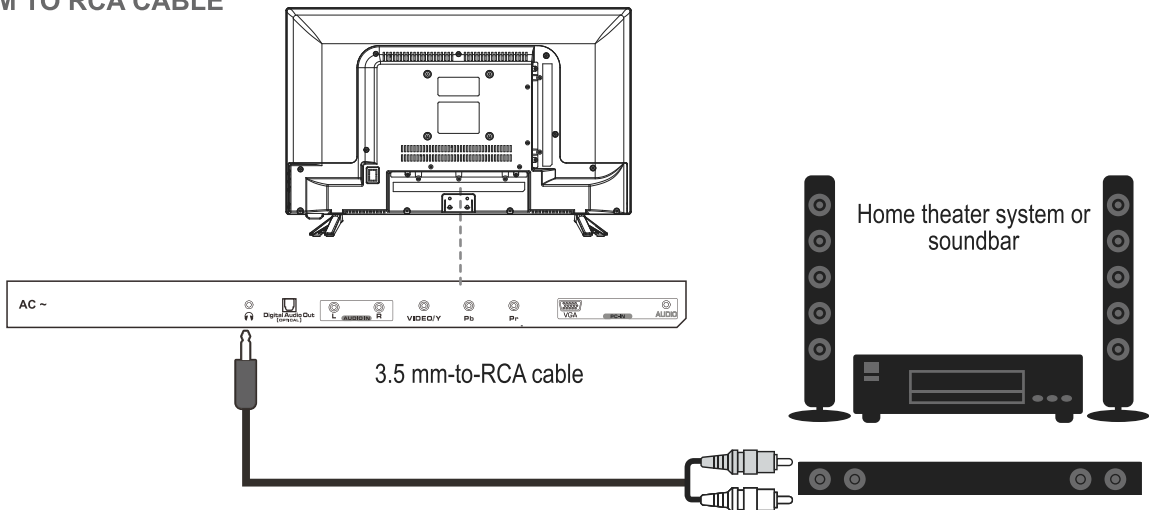

1. To listen to audio through your home theater system or soundbar, connect the 3.5 mm connector from the headphone jack on the back of your TV.
2. Connect the RCA end of the cable to the audio in jacks on your home theater system or soundbar. The connectors' colors should match the TV jacks' colors.

## STREAMING DEVICES

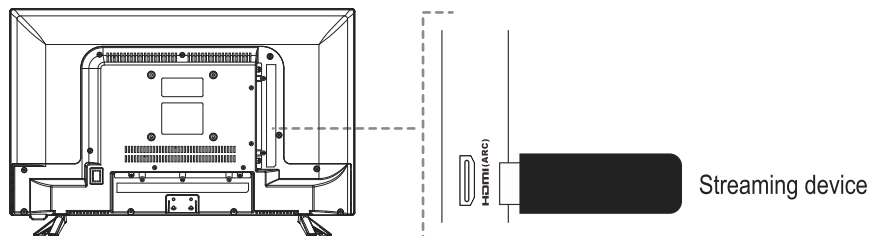

- Connect your streaming device to the **HDMI** port on the back of your TV.

Some streaming devices need to connect to power. See the instructions that came with your streaming device for more information.

## FIRST USE

### PLUGGING IN THE TV

1. Make sure that all of your peripheral devices are connected to your TV.
2. If the power cord is not attached to your TV, plug it into the socket on the back of your TV.

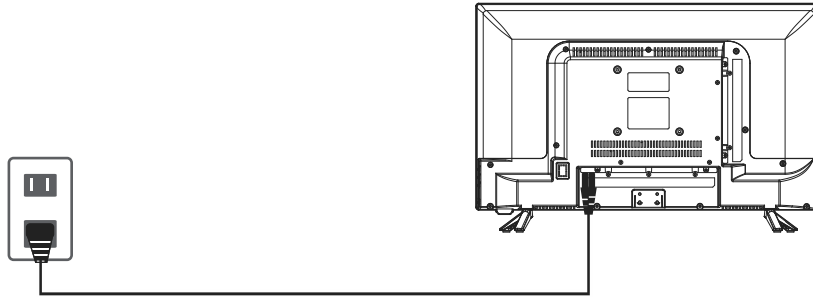

3. Connect the power cord to a power outlet. The TV enters standby mode and its indicator lights red.
4. Press  $\mathcal{P}$  (power) on the TV or remote control to turn on the TV. The red indicator turns off.

**i** The  $\mathcal{P}$  (power) button on the TV or remote control can only switch the TV into standby mode. To completely turn off the TV, disconnect the power cord from the power socket.

### SETUP WIZARD

- Press the  $\blacktriangledown\blacktriangle\blacktriangleleft\blacktriangleright$  buttons to select or change a setting:
  - **Menu Language:** Select the language you want to be displayed in the menu. The default language is English.
  - **Air/Cable:** Select whether you want to watch TV with an antenna (Air) or through a cable/satellite box (Cable).
  - **Auto Scan:** If you want to watch TV with an antenna or through a cable box, search and store available channels.



## OPERATING THE TV

### TURNING ON/OFF

Press **⏻** (power) on the TV or remote control to turn your TV on or off. The LED lights red while in standby mode (off) and the LED light off when turned on.

**i** The **⏻** (power) button on the TV or remote control can only switch the TV into standby mode. To completely turn off the TV, disconnect the power cord from the power outlet.

### SELECTING AN INPUT

1. Press the **INPUT** button on your TV or remote to display the INPUT List.
2. Press the **▼▲** buttons to select your input source, then press the **OK** button to confirm.



### SELECTING CHANNELS

When watching cable TV or TV with an antenna:

- Press the **CH▼/CH▲** buttons on the TV or remote repeatedly to select a channel.
- Press the **0-9** buttons on the remote control to select a channel directly.

### ADJUSTING THE VOLUME

- Press the **VOL+/-** buttons on the TV or on the remote to adjust the volume.
- Press the **⊘ MUTE** button to turn the sound off. To resume the sound, press the **VOL+** button or **⊘ MUTE** again.

### VIEWING USB MULTIMEDIA

**i** The TV supports JPEG files.

1. Connect a flash drive to the USB port on the back of your TV.
2. Press the **MEDIA** button on your remote, or press the **INPUT** button repeatedly to select the **MEDIA** input source.
3. Select **PHOTO**, use the **▼▲◀▶** buttons to browse, and then press **OK** to select a photo or folder.
4. To view photos:
  - **▶Play/ || Pause**: Press to start or pause the photo playback.
  - **■ Stop**: Press to stop photo playback.
  - **◀◀ Skip back**: Press to view the previous photo.
  - **▶▶ Skip forward**: Press to view the next photo.

# CUSTOMIZING TV SETTINGS

Learn how to navigate your TV's menu and review the available options in the Picture, Audio, Time, Setup, Lock, and Channel menus.

## NAVIGATING THE SETTINGS MENU

1. Press the **MENU** button to open the menu.
2. Press the **▼▲** buttons to select a menu category, then press the **▶** button or **OK** to make changes in the category.
3. Press the **▼▲** buttons to select a setting, then press the **◀▶** button to change the setting.
4. When you are finished, press the **EXIT** button to save your changes and close the menu.



↓ See “ Video ” on page 22



↓ See “ Audio ” on page 22



See “ TIME ” on page 23



↓ See “ SETUP ” on page 23



↓ See “ LOCK ” on page 25



See “ CHANNEL ” on page 26

## CUSTOMIZING TV SETTINGS (CONT.)

### PICTURE



Options include:

- **Picture Mode:** Cycle through the picture modes: Dynamic,Standard,Movie,User.



You can press the **P.MODE** button on your remote to quickly change the picture mode.

- **Brightness:** Increase or decrease the amount of white in the picture.
- **Contrast:** Adjust the difference between light and dark levels in the pictures.
- **Color:** Control the color intensity.
- **Tint:** Adjust the balance between red and green levels.
- **Sharpness:** Adjust the level of crispness in the edges between light and dark areas of the picture.
- **Color Temperauter :** Cycle through color temperatures: Cool,Warm ,Standard.
- **Advanced Settings:** Adjust advanced video features to fine tune the picture.

### AUDIO



Options include:

- **Sound Mode:** Select an audio-enhancement technique: Standard,User,Movie,Sports,Music



You can press the **S.MODE** button on your remote to quickly select the sound mode.

- **Treble:** Control the relative intensity of higher-pitched sounds.
- **Bass:** Control the relative intensity of lower-pitched sounds.
- **Balance:** Adjust the audio output between the left and the right speakers.

## CUSTOMIZING TV SETTINGS (CONT.)

### AUDIO (CONT.)

- **MTS:** Select the MTS: Stereo, SAP, Mono.
- **Audio Language:** Select the audio language: English, French, Spanish.
- **Digital Output:** Select the digital audio output mode: Off, RAW or PCM
- **Surround Sound:** Select the Surround Sound : on, off.
- **Perfect Volume:** Select the Perfect Volume: on, off.

### TIME



Options include:

- **Sleep Timer:** Select a period of time after which the TV automatically switches to standby mode: off, 5, 10, 15, 30, 60, 90, 120, 180, or 240 minutes.
- **Time Zone:** Select a time zone: Pacific, Alaska, Hawaii, Atlantic, Eastern, Central, or Mountain



You can press the SLEEP button on your remote to quickly set the sleep timer.

- **Daylight Savings :** Select to turn daylight saving time on or off.
- **Time Format:** Select a period of time after which the TV automatically switches to standby mode: 12-hour, 24-hour.
- **Auto Clock:** Select to Auto Clock on or off.
- **Clock:** Select to Clock .

### SETUP



Options include:

- **Menu Language:** Select a menu language: English or Español. The default on-screen menu language is English.
- **OSD Timeout:** 5S, 15S, 30S, 45S, 60S.
- **Closed Caption:** Press ▼▲ button to select Closed Caption, then press ► button to enter.



The zoom mode options may differ depending on the selected input source.

# CUSTOMIZING TV SETTINGS (CONT.)

## SETUP (CONT.)

- **Input Label:** Press ▼ ▲ button to select
- **Other Settings:** Press ▼ ▲ button to select Other Settings, then press OK button to enter. Press ► button to select Audio Only, then press ► button to set On or Off..
- **Reset:** Recall the default setting.
- **Setup Wizard:** Press OK or to enter relevant options including the time zone and on-screen display language.
- **HDMI CEC:** CEC Control/Device Auto Power Off/TV Auto Power On/ARC/Device Lists/Connect/Root Menu.
- **Voice Guidance:** Press ▼ ▲ button to select Voice Guidance then press ► button to select Voice Guidance/Volume/Speed/Pitch.







- **CC Mode:** Select CC On, CC Off, or CC on Mute.
- **Analog CC:** Select the analog mode: CC1, CC2, CC3, CC4, Text1, Text2, Text3, or Text4.
- **Digital CC:** Select digital mode: Service 1, Service 2, Service 3, Service 4, Service 5, or Service 6 ,Off.
- **Option:** Personalize the captioning style, such as the size and color of the digital caption.

**i** • HDMI CEC lets you control multiple HDMI devices (for example, your TV and Blu-ray player) with one remote. Your included remote does not support this feature.  
 • HDMI ARC lets audio signals travel both into and out of a device with a single ARC HDMI connection.



## CUSTOMIZING TV SETTINGS (CONT.)

### LOCK

The Lock menu lets you block undesirable programming by defining which program ratings you consider acceptable to the younger or more sensitive viewer. It can be turned on or off with a four-number password. See **“SEARCHING FOR CHANNELS”** on page 26 for more information.

1. Press the  MENU button on the TV or remote.
2. Press the   to select the Lock menu, then press the  button or OK.
3. Use your remote's number pad to input the four-digit password to enter the LOCK menu. The default password is 0000.









4. Press the   buttons to select a setting, then press the  button to change it.
  - **Change Password:** Change the parental control password. See **“CHANGING THE PASSWORD”** on page 27 for instructions.



Do not forget your password. It is the only way you can access the Parental Control menu and change rating selections, or turn Parental Control off.



- **Keypad Lock:** Select to turn the Keypad lock on or off.
- **Parental Control:** Select to turn the Parental Control on or off.
- **US Rating:** View and select MPAA ratings for US programs.
  - » **TV:** Select to lock or unlock TV ratings.
  - » **MPAA:** Select the highest MPAA rating that can be viewed: Off,G,PG,PG-13,R,NC-17,X.
- **Canada Rating:** View and select MPAA ratings for Canadian programs.
  - » **Canada English:** Select the highest MPAA rating that can be viewed for English-speaking Canada: Off,C,C8+,G,PG,14+,18+.
  - » **Canada French:** Select the highest MPAA rating that can be viewed for Quebec Canada: Off,G,8ans+,13ans+,16ans+,18ans+.
- **Region 5:** Press   button to select Region 5, then press  button to enter.
- **Reset Region 5:** Press   button to select Reset Region 5, then press  button to enter.

## CUSTOMIZING TV SETTINGS (CONT.)

### CHANNEL



Options include:

- **Air/Cable:** Select whether you want to watch TV with an antenna (Air) or through a cable box (Cable).
- **Auto Channel Scan:** Search and store available channels automatically.

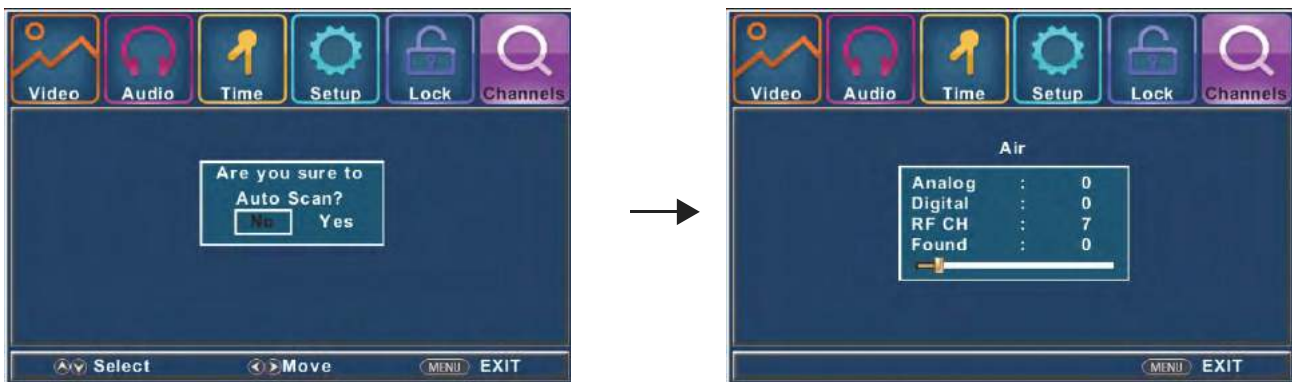

- **Favorite:** Set the channel as a favorite channel.



- **Channel List:** Display the current channel List.
- **View/Skip:** Press ▼ ▲ button to select View/Skip, then press ► button to enter.
- **Channel Number:** Display the current channel number.
- **Channel Label:** Display the current channel label or change the current channel label.

## SEARCHING FOR CHANNELS

1. Press the **MENU** button to open the menu.
2. Press the **▼▲** buttons to select the **CHANNEL** category, then press the button or **OK** to make changes.
3. Press the **▼▲** buttons to select Air/Cable, then press the **◀▶** buttons to select whether you want to watch TV with an antenna (**Air**) or through a cable (**Cable**).
4. Press the **▼▲** buttons to select **Auto Scan** to search and store available channels automatically.
5. When you are finished, press the **EXIT** button to save your changes and close the menu.

## SETTING PARENTAL CONTROLS

Learn about parental control ratings, change your password, and block content. For a complete list of lock options, see **“LOCK” on page 24**.

### CHOOSING VIEWER RATINGS

For complete coverage, set blocks for both general audiences and children. Viewer ratings can be specified for both TV and movies. The ratings are based on the ages of children.

Use the following tables to determine which ratings you consider acceptable to the viewer. For example, if you choose TV-PG, more restrictive ratings will be automatically blocked, and the viewer will not be able to see: TV-PG, TV-14, or TV-MA rated programming.

#### MOTION PICTURE ASSOCIATION OF AMERICA (MPAA) RATING SYSTEM

GRADE		DESCRIPTION
<b>G</b>	General Audiences	Content not offensive to most viewers.
<b>PG</b>	Parental Guidance Suggested	Parents may not want their children to view the program.
<b>PG-13</b>	Parents Strongly Cautioned	Program is inappropriate for pre-teens, with a greater degree of offensive material suggested than a PG rated program.
<b>R</b>	Restricted	Not for children under 17. Program contains an element of sex and/or violence.
<b>NC-17</b>	No children under age 17	Not for children under 17 under any circumstances. Program contains strong sexual content.
<b>X</b>	Hard Core Films	Same as NC-17 rating.
<b>No Rating</b>		MPAA Not Rated.

#### TV PARENTAL GUIDELINE RATING SYSTEM

GRADE		DESCRIPTION
<b>TV-Y</b>	All children	Content not offensive to most viewers.
<b>TV-Y7</b>	Directed to older children	Considered suitable for children over seven. Program may contain fantasy violence scenes.
<b>TV-G</b>	General audience	Considered suitable for all audiences. Children may watch unattended.
<b>TV-PG</b>	Parental guidance suggested	Suggested unsuitable for younger children. Program may contain suggestive language, bad language, sex, and violence scenes.
<b>TV-14</b>	Parents strongly cautioned	Unsuitable for children under 14. Program may contain strong language, bad language, sex, and violence scenes.
<b>TV-MA</b>	Mature audiences only	Adults only. Program may contain strong language, bad language, sex, and violence scenes.

## SETTING PARENTAL CONTROLS (CONT.)

### Canadian Rating:

- Canadian English is used throughout all English-speaking Canada :Off,C,C8+,G,PG,14+,18+.
- Canadian French is used in Quebec :Off,G,8ans+,13ans+,16ans+,18ans+.

### CHANGING THE PASSWORD

1. Press the  **MENU** button on the TV or remote.
2. Press **▼▲** to select the Lock menu, then press the **▶** button or **OK** to make changes.
3. Use your remote's number pad to input the four-digit password to enter the Lock menu. The default password is 0000.



4. Press the **▼▲** buttons to select **Change Password**, then press the **▶** button to change it.
5. Use the number pad on your remote to input your new four-digit password, then re-enter the new password for confirmation. Your new password is automatically saved.

 Do not forget your password. It is the only way you can access the Parental Control menu and change rating selections, or turn Parental Control off. Unplugging the TV will not reset the password.

### BLOCKING CONTENT

You can block program content based on viewer ratings or individual parameters such as strong dialog, bad language, sex scenes, violence scenes, or fantasy.

1. Press the  **MENU** button on the TV or remote.
2. Press **▼▲** to select the Lock menu, then press the **▶** button or **OK**.
3. Use your remote's number pad to input the four-digit password to enter the Lock menu.

 The default password is 0000.

4. Press the **▼▲** buttons to select **System Lock**, then press the **▶** button to change it to **On**.
5. Select **US**, then select **TV**. A grid of options is displayed.
6. Move the cursor to a cell in the grid and press **OK** to lock or unlock that item.

 Locking something like TV-PG Violence (V) will also lock violence for the higher ratings levels. Or, if you unlock violence at the highest level, it will automatically unlock violence for all of the ratings below it.

## MAINTAINING YOUR TV

Do not use your TV in areas that are too hot or too cold because the cabinet may warp or the screen may malfunction. Do not place your TV in direct sunlight or near a heat source. Your TV works best in temperatures that are comfortable to you.

- Leave at least 2 inches (5 cm) around the TV for sufficient ventilation.
- Do not block the ventilation openings with items, such as newspapers, tablecloths, curtains, etc.
- Do not place open flame sources, such as lighted candles, on the TV.
- Dispose of batteries following local laws.

## CLEANING YOUR TV



**WARNING:** Turn the power off and unplug the power cord before you begin any cleaning.

- To remove dirt or dust from the cabinet or screen, wipe with a soft, dry, lint-free cloth. Do not to use a wet cloth.

## SPECIFICATIONS

Model number	ONA24HB19E02
Screen Size (Diagonal)	23.6 inch
Resolution	1366X768
Refresh Rate	60Hz
VESA Wall Mount	100X100mm
VESA Max Screw Depth	5.5mm
Video Connections	TV,AV,Component,HDMI(ARC),PC,Media
Audio Connections	RCA, Earphone, Optical Out, PC Audio In
TV with Stand	21.9in (W) x 14.4in (H) x 6.5in (D) 4.8 (LBS)
TV without Stand	21.9in (W) x 13.4in (H) x 3.1in (D) 4.7 (LBS)
Storage Temperature	14°F~140°F
Working Temperature	32°F ~104°F
Warranty	1 Year

## TROUBLESHOOTING

PROBLEM	SOLUTION
Dead. No LED lit.	Make sure that the power cord is connected to a working wall outlet.
Blue screen only.	Press the <b>SOURCE</b> button to select the correct source.
Noisy, snowy, ghosting picture (TV).	<ul style="list-style-type: none"> <li>• If using an indoor antenna, try adjusting the antenna position.</li> <li>• Check antenna connections.</li> </ul>
No sound.	<ul style="list-style-type: none"> <li>• Make sure that the TV isn't muted.</li> <li>• Turn up the volume.</li> <li>• Unplug any headphones connected to the TV.</li> <li>• Make sure that your audio cables are connected correctly.</li> <li>• Make sure that any connected speakers are turned on and that the volume is turned up.</li> <li>• Make sure that surround sound is selected in the Audio menu options.</li> <li>• Make sure that the correct input source is selected.</li> </ul>
No sound and picture.	<ul style="list-style-type: none"> <li>• Make sure that the power cord is connected to a working wall outlet.</li> <li>• Press POWER on the front of the TV.</li> <li>• Check the picture contrast and the brightness settings.</li> </ul>
Red LED indicator lights.	TV is in standby mode. Press the Power button or on the remote control.
Normal picture but no sound.	<ul style="list-style-type: none"> <li>• Check that the TV isn't muted.</li> <li>• Turn up the volume.</li> <li>• Unplug any headphones connected to the TV.</li> <li>• Check the connections on your connected devices.</li> <li>• Try another channel. The problem may be with the broadcast.</li> <li>• Make sure that your audio cables are connected correctly.</li> </ul>
The remote control does not work.	<ul style="list-style-type: none"> <li>• Make sure there are no objects between the TV and remote control causing obstruction.</li> <li>• Make sure that the batteries are installed with the correct polarity (-/+).</li> <li>• Install new batteries.</li> </ul>
Power suddenly turns off.	<ul style="list-style-type: none"> <li>• The sleep timer may have been set.</li> <li>• Check the power cord to make sure that it is fully connected to the power outlet.</li> <li>• There may be no broadcast on the station you are tuned to. Try changing the channel.</li> </ul>
Picture appears slowly after turning on.	This is normal. The image is muted during the startup process. Contact a service provider if the picture has not appeared after five minutes.
Poor color or picture.	<ul style="list-style-type: none"> <li>• Adjust the color in the menu options.</li> <li>• Try another channel. The problem may be with the broadcast.</li> <li>• Make sure that all video cables are connected correctly.</li> </ul>
Horizontal/Vertical bars or picture is shaking.	Check for local interference, such as an electrical appliance or power tool.

<b>PROBLEM</b>	<b>SOLUTION</b>
Poor reception on some channels.	<ul style="list-style-type: none"> <li>• The station may be experiencing problems. Tune to another station.</li> <li>• Station signal is weak. Reorient the antenna for better reception.</li> <li>• Check for sources of possible interference.</li> </ul>
No output from one of the speakers.	Adjust the balance in the menu options.
The picture is fuzzy or blacks out while watching TV.	<ul style="list-style-type: none"> <li>• Make sure that a cable is not disconnected or loose.</li> <li>• Make sure that the correct input source is selected.</li> </ul>
The computer image is in the incorrect position.	<ul style="list-style-type: none"> <li>• In the Setup menu, open the Advanced options to set the auto-configure or adjust the clock, phase, or horizontal/vertical position (for VGA connections only).</li> <li>• Adjust the screen resolution using your computer's settings.</li> </ul>
Screen color is unstable or is a single color.	<ul style="list-style-type: none"> <li>• Make sure that your video cables are correctly connected.</li> <li>• Reinstall your PC video card.</li> </ul>

---

## LEGAL NOTICES

### FCC Notes



- **Warning:** Changes or modifications to this unit not expressly approved by the party responsible for compliances could void the user's authority to operate the equipment.
- **NOTE:** This equipment has been tested and found to comply with the limits for a Class B digital device, pursuant to Part 15 of the FCC Rules. These limits are designed to provide reasonable protection against harmful interference in a residential installation. This equipment generates, uses, and can radiate radio frequency energy and, if not installed and used in accordance with the instructions, may cause harmful interference to radio communications. However, there is no guarantee that interference will not occur in a particular installation. If this equipment does cause harmful interference to radio or television reception, which can be determined by turning the equipment off and on, the user is encouraged to try to correct the interference by one or more of the following measures:
  - Reorient or relocate the receiving antenna.
  - Increase the separation between the equipment and receiver.
  - Connect the equipment into an outlet on a circuit different from that to which the receiver is connected.
  - Consult the dealer or an experienced radio/TV technician for help.



The terms HDMI and HDMI High-Definition Multimedia Interface, and the HDMI Logo are trademarks or registered trademarks of HDMI Licensing Administrator, Inc in the United States and other countries.



■ This product contains electrical or electronic materials. The presence of these materials may, if not disposed of properly, have potential adverse effects on the environment and human health. Presence of this label on the product means it should not be disposed of as unsorted waste and must be collected separately. As a consumer, you are responsible for ensuring that this product is disposed of properly.